

CS425

Computer Systems Architecture

Fall 2023

Branch Prediction

Branch Prediction

- Branch prediction is very important to achieve good performance. Why?

```
MULT F0, F1, F2
```

```
DIVD F4, F0, F3
```

```
BNEZ F4, Loop
```

- Important in out-of-order or multi-issue processors (Amdahl's Law)
CPI = Ideal CPI + Structural stalls + RAW stalls +
WAR stalls + WAW stalls + **Control stalls**
- The prediction is a hint that is assumed to be correct, and fetching begins in the predicted direction. If the hint turns out to be wrong, the executed (not committed) instructions from the wrong path are cancelled.
- **This lecture presents the following topics:** branch prediction, branch target address, cancel branch mispredictions

Predicting the Branch Outcome

- Why does branch prediction work?
 - Underlying algorithm has regularities.
 - Data that is being operated on has regularities.
 - Instruction sequence has redundancies that are artifacts of way that humans/compiler think about problems.
 - Loops are easy to predict their behavior

Static Branch Prediction

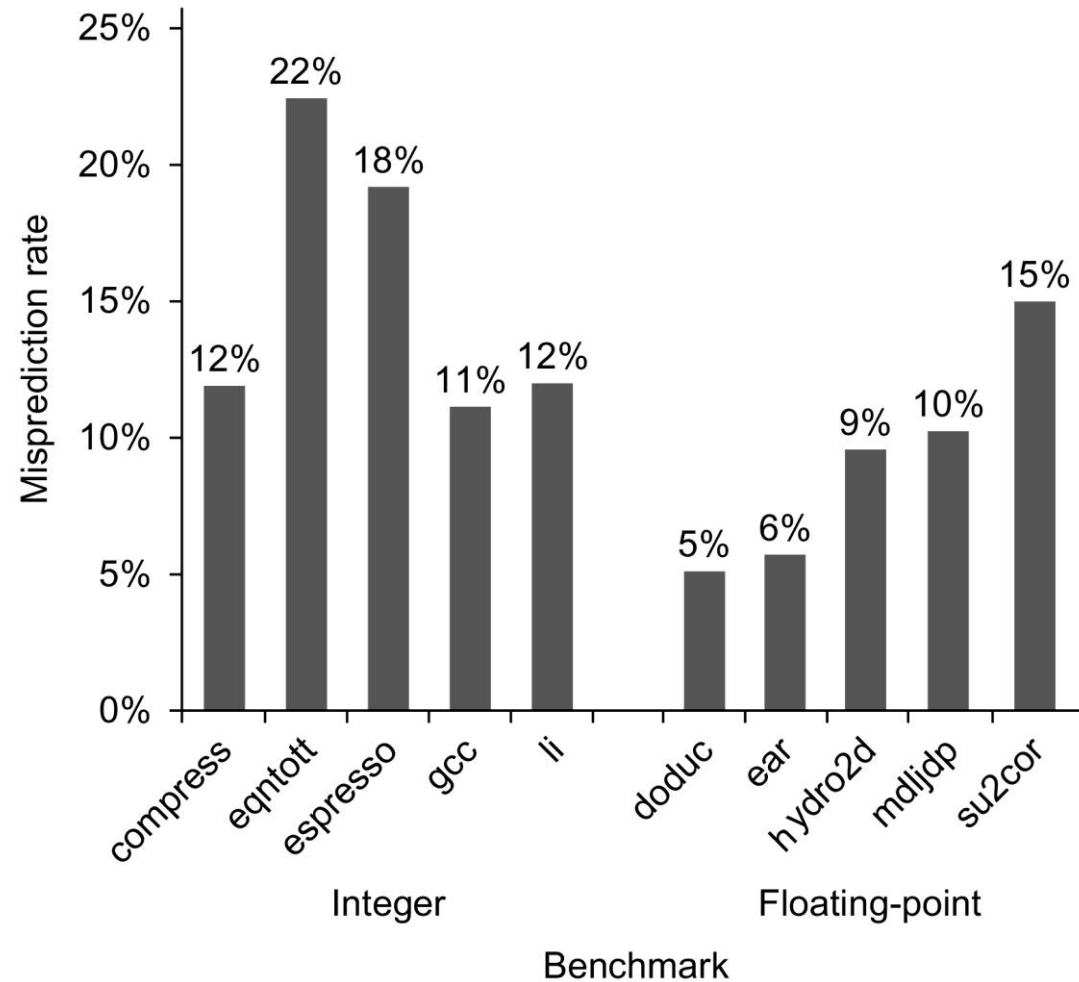

- **Major limitation:** misprediction rate for the integer programs is high

Dynamic Branch Prediction

- Is dynamic branch prediction better than static?
 - Josh Fisher had good paper on “Predicting Conditional Branch Directions from Previous Runs of a Program”, ASPLOS ‘92.
 - In general, good results if allowed to run program for lots of data sets.
 - How would this information be stored for later use?
 - Still some difference between best possible static prediction (using a run to predict itself) and weighted average over many different data sets

Simplest Dynamic Approach: Branch History Table

- Performance = $f(\text{accuracy}, \text{cost of misprediction})$
- **Branch History Table (BHT):** Lower bits of PC index 1-bit table
 - Specifies if branch was taken or not the last time
 - When branch delay is longer than time to compute target PC

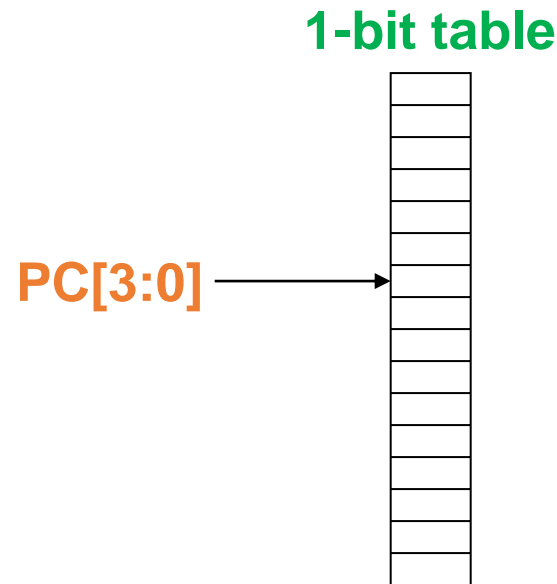

1-bit BHT: Limitations?

```
Loop: LD    F0,0(R1) ;F0=vector element
      ADDD F4,F0,F2 ;add scalar from F2
      SD    F4,0(R1) ;store result
      SUBI R1,R1,8  ;decrement pointer 8B (DW)
      BNEZ R1,Loop ;branch R1!=zero
      NOP          ;delayed branch slot
```

- **Limitation** → in a loop, 1-bit BHT causes 2 mispredictions
 - **first time** through loop code, when it predicts exit instead of looping
 - **end of loop** case, when it predicts looping instead of exit

2-bit Prediction Scheme (Jim Smith, 1981)

- **Solution** → 2-bit scheme that changes prediction when two consecutive wrong predictions happen:
- **Brown States:** taken
- **Blue States:** not taken
- Adds **hysteresis** in predictions
- Also known as saturation counter or bimodal predictor

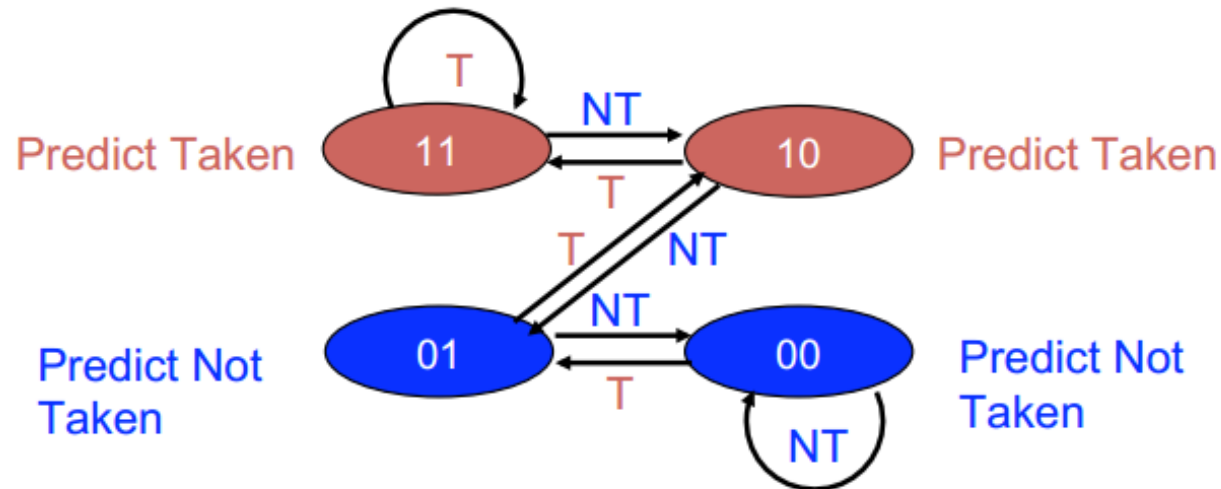

n-bit Predictors

- An **n-bit scheme** changes the direction of the prediction when there are 2^{n-1} mispredictions in a row.
- Use **n-bit counters**
- Detailed evaluations of n-bit predictors have shown that **2-bit predictors are very effective and accurate:**
 - most systems today use 2-bit predictors.

Use of Branch History Table

- BHT is an array of “Predictors”
 - Usually 2-bit, saturating counters
 - Indexed by PC address of Branch
- Access the BHT during the ID stage *[or some IF stage(s)]*. The target address of a branch is computed during the ID stage (needs 1 delay slot)
- When the branch outcome has been evaluated:
 - Update corresponding Predictor

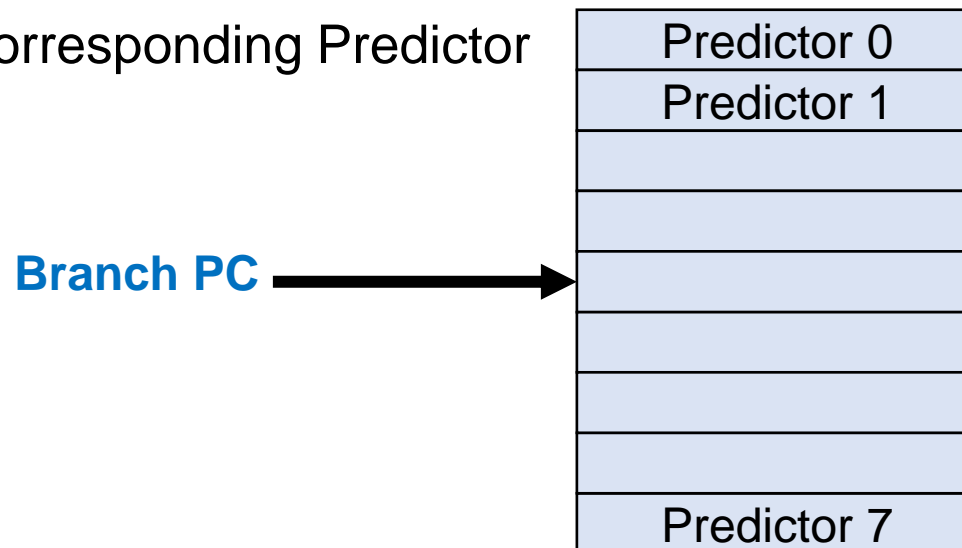

2-bit BHT Accuracy

- **Mispredictions:**
 - Wrong guess for that branch
 - Got branch history of wrong branch (aliasing)

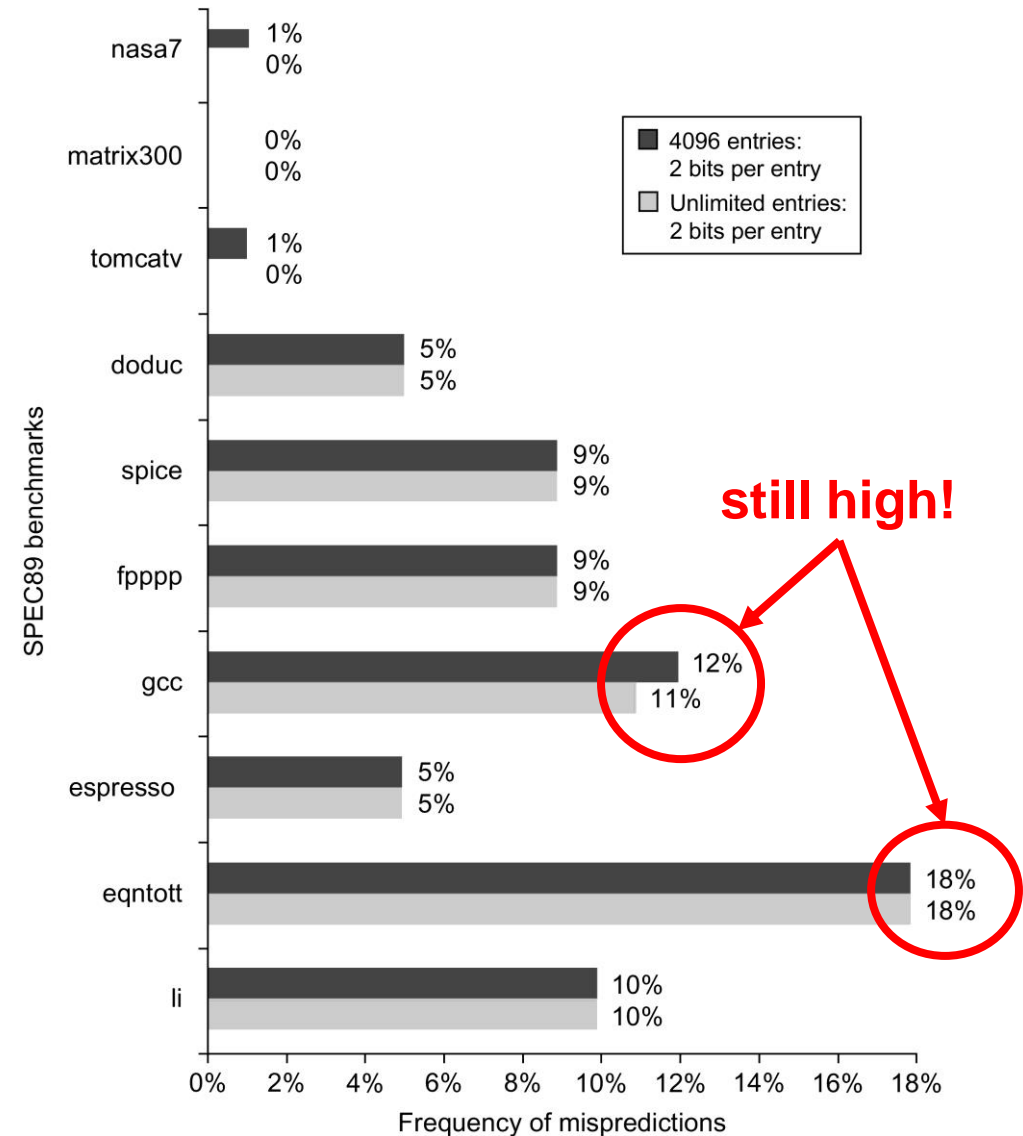

Correlating Predictors (Example 1)

- **Assumption:** recent branches are correlated! The outcomes of recent branches affect the prediction of the current branch.

Example in C (from eqntott benchmark)

```
if (aa==2)
    aa=0;
if (bb==2)
    bb=0;
if (aa != bb) {...}
```

*If branches **b1** and **b2** are both not taken (i.e. first two if statements are true) then **b3** will be taken*

Example in assembly

```
        DSUBUI    R3,R1,#2
        BNEZ     R3,L1      ;branch b1 (aa!=2)
        DADD     R1,R0,R0   ;aa=0
L1:     DSUBUI    R3,R2,#2
        BNEZ     R3,L2      ;branch b2 (bb!=2)
        DADD     R2,R0,R0   ;bb=0
L2:     DSUBU    R3,R1,R2   ;R3=aa-bb
        BEQZ     R3,L3      ;branch b3 (aa==bb)
```

Correlating Predictors (Example 2)

Example in C

```
if (d==0)
    d=1;
if (d==1) {...}
```

Example in assembly

```
        BNEZ      R1,L1      ;branch b1 (d!=0)
        DADDIU   R1,R0,#1    ;d==0, so d=1
L1:     DADDIU   R3,R1,#-1
        BNEZ      R3,L2      ;branch b2 (d!=1)
...
L2:
```

Possible execution sequences

Initial value of d	d==0?	b1	Value of d before b2	d==1?	b2
0	yes	not taken	1	yes	not taken
1	no	taken	1	yes	not taken
2	no	taken	2	no	taken

Example: (4,2) Predictor

- (4,2) GHT (Global History Table) predictor
 - 4 means that we keep four bits of history
 - 2 means that we have 2 bit counters in each slot.
 - Then behavior of recent branches selects between, say, 16 predictions of next branch, updating just that prediction
 - Note also that aliasing is possible here...

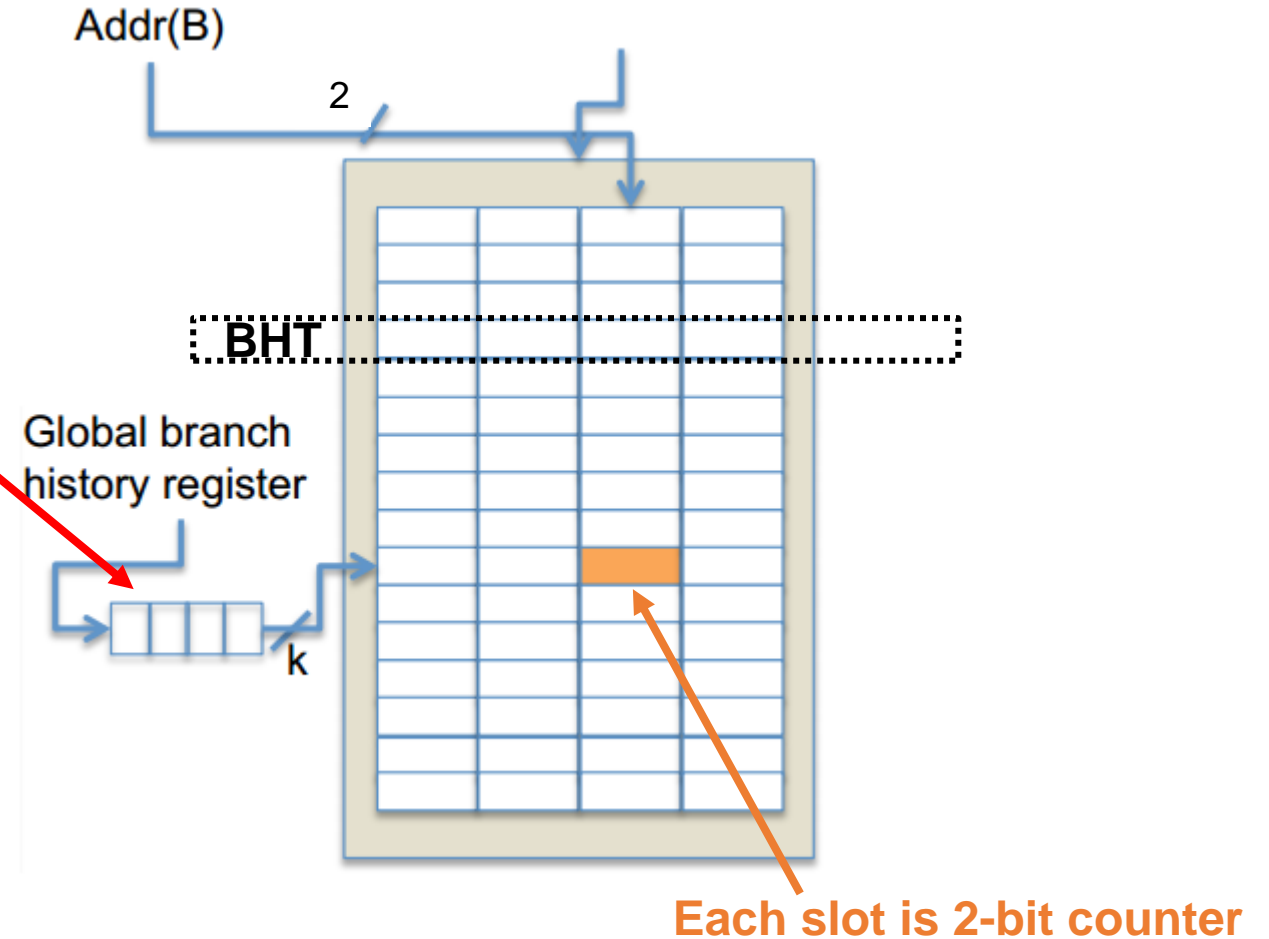

Correlating Branches

- **(k, n) GHT predictor**
 - k means that we keep k-bits of history
 - n means that we have n-bit counters in each slot.
 - Note that the original two-bit counter solution would be a (0,2) *GAp predictor*
 - Total memory/state bits:
 - $2^k * 2^{\text{addr_size}} * n = 2^{k+\text{addr_size}} * n$
 - Trivial amount of additional HW

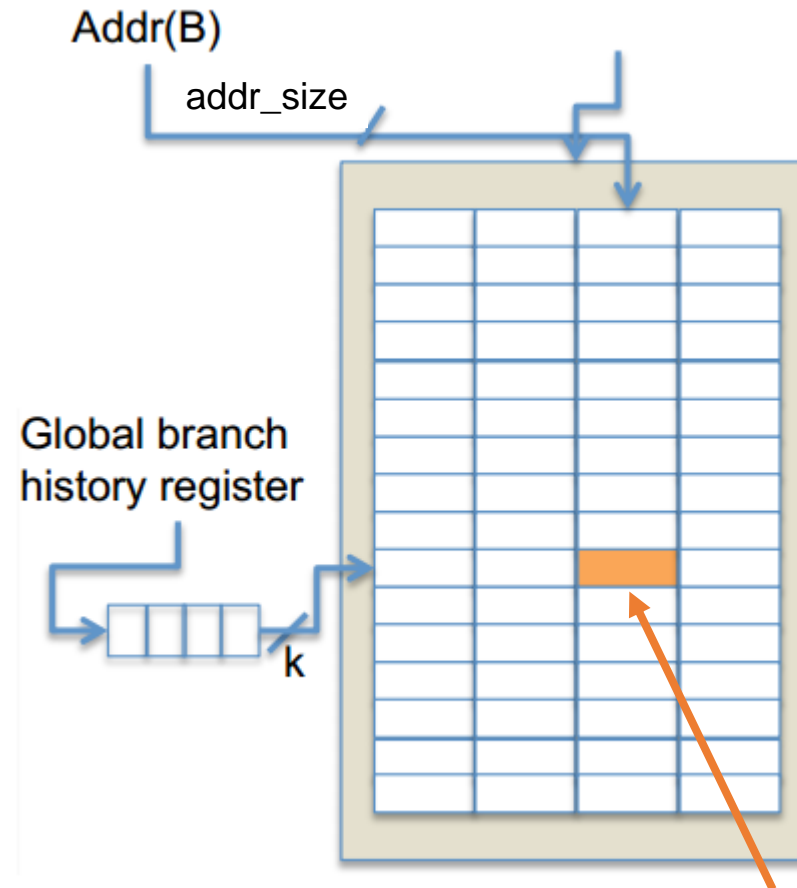

Each slot is n-bit counter

Accuracy of Different Schemes

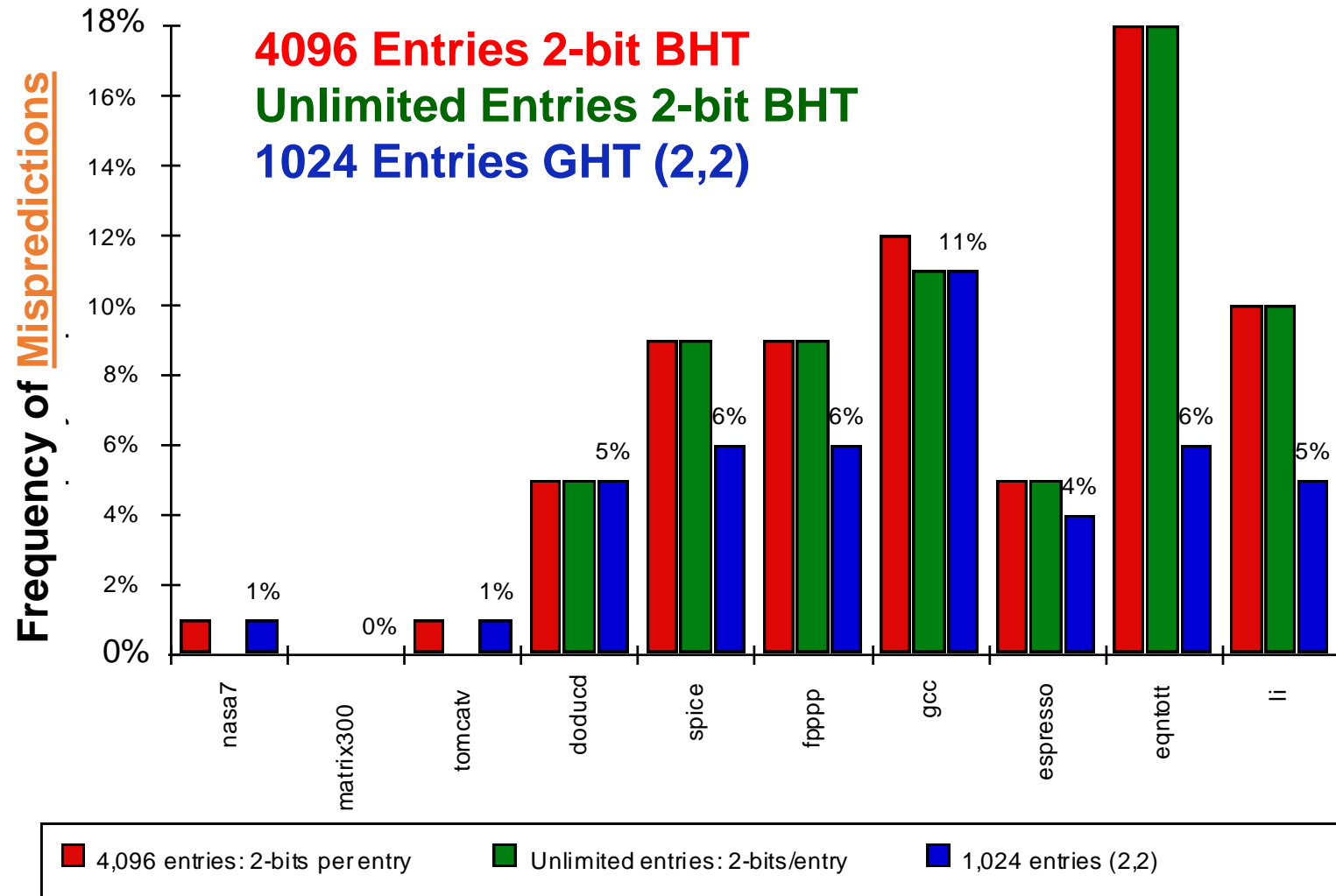

Yeh and Patt's classification (ISCA'92)

Taxonomy of two-level branch predictors

- ▶ XAy predictor
- ▶ $X=G$, global history register
- ▶ $X=P$, per-branch history register
- ▶ $X=S$, per-set-of-branches history register
- ▶ $y=g$, global branch history table
- ▶ $y=p$, per-branch history table
- ▶ $y=s$, set-associative per branch history table
 - ▶ Set-associative mapping of branch PCs reduces conflicts (aliases)

Yeh and Patt's classification

- First Level:
 - the K most recent outcomes that have occurred from any branch in the program
 - Produces a “GAy” (for “global address”) in the Yeh and Patt classification
 - the K most recent outcomes of the same branch
 - Produces a “PAy” (for “per address”) in same classification (e.g. PAg)

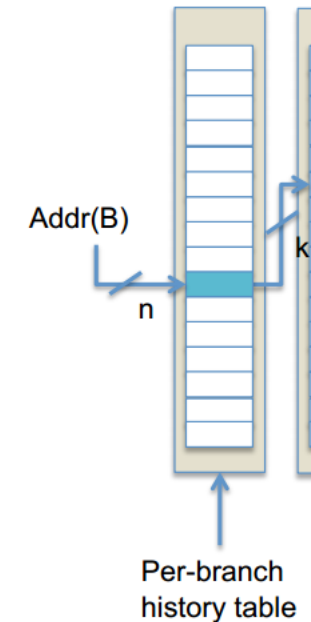
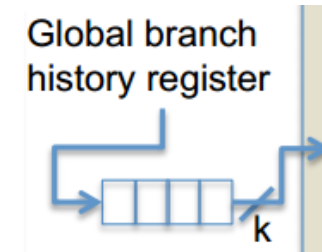

Yeh and Patt's classification

- Second Level:
 - Single entry for any branch “XAg”
 - Per branch history table “XAp”

- Per set history table “XAs”
 - The set attribute of a branch can be determined by the branch opcode, branch class assigned by a compiler, or branch address.

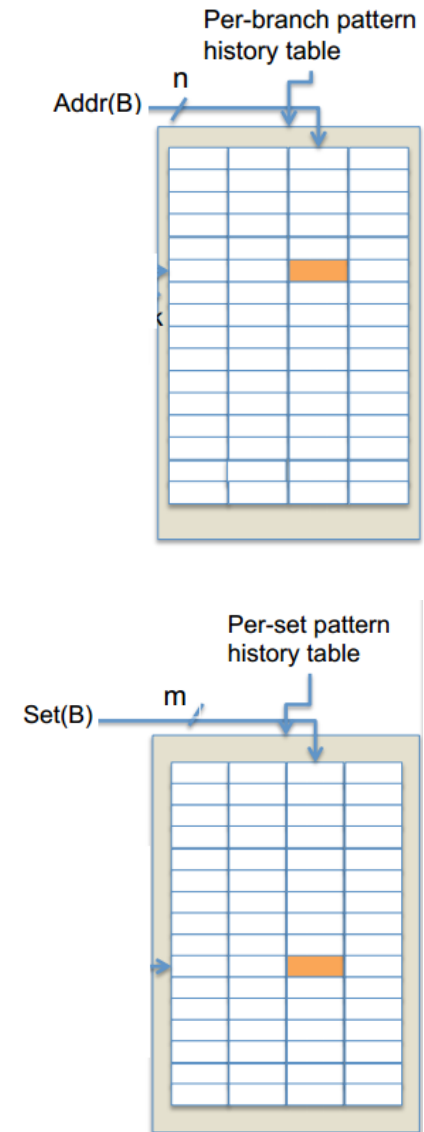

Yeh and Patt's classification

Variations of two-level branch predictors

Variation	Description
GAg	Global Adaptive Branch Prediction using one global pattern history table
GAs	Global Adaptive Branch Prediction using per-set (of branch PCs) pattern history tables
GAp	Global Adaptive Branch Prediction using per-address (of branch PC) pattern history tables
PAg	Per-address Adaptive Branch Prediction using global pattern history table
SAg	Per-Set Adaptive Branch Prediction using global pattern history table
SAs	Per-Set Adaptive Branch Prediction using per-set pattern history tables
SAp	Per-Set Adaptive Branch Prediction using per-address pattern history tables

Yeh and Patt's classification

Global history predictors

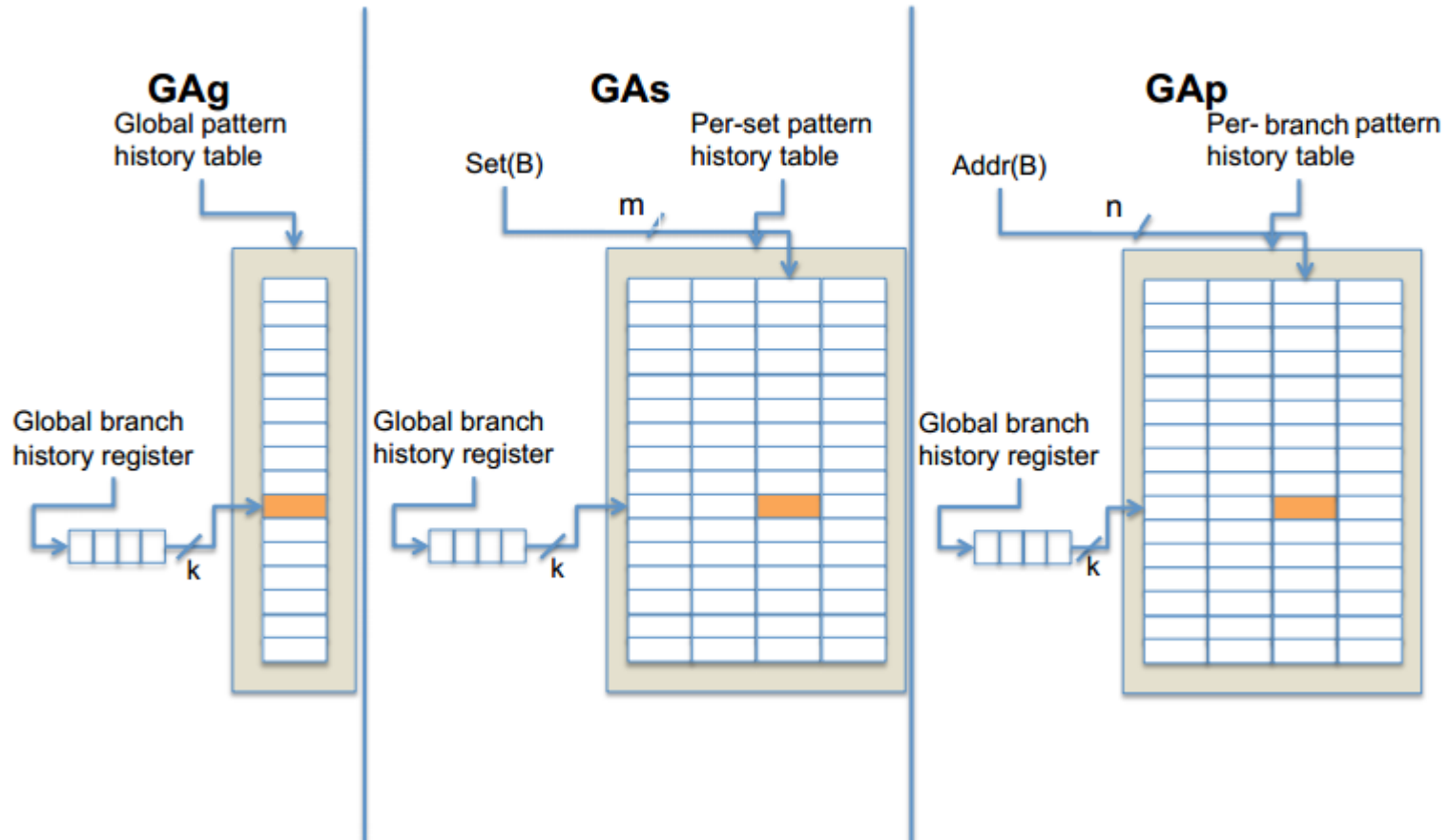

Yeh and Patt's classification

Per-branch history predictors

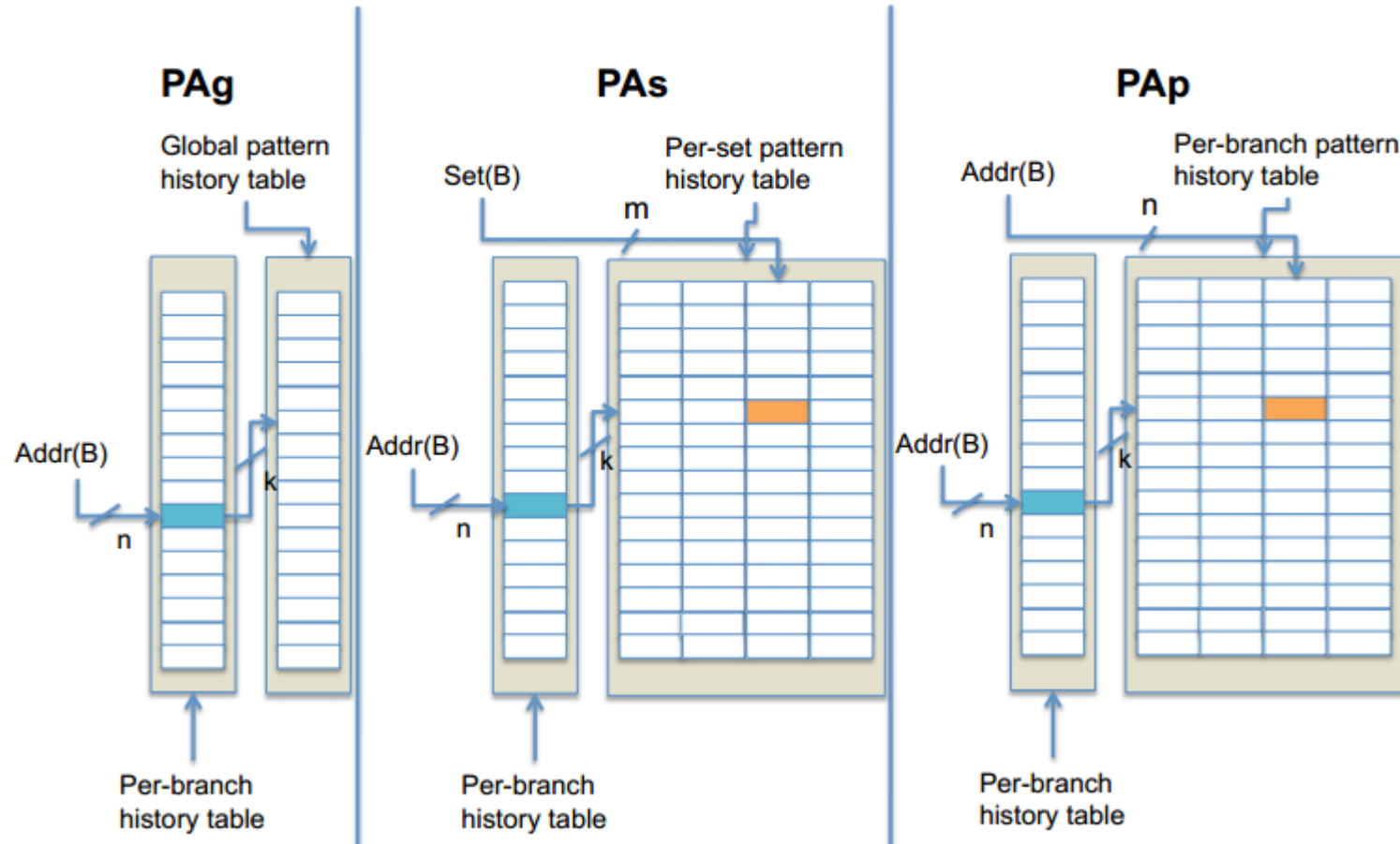

Yeh and Patt's classification

Per-set history predictors

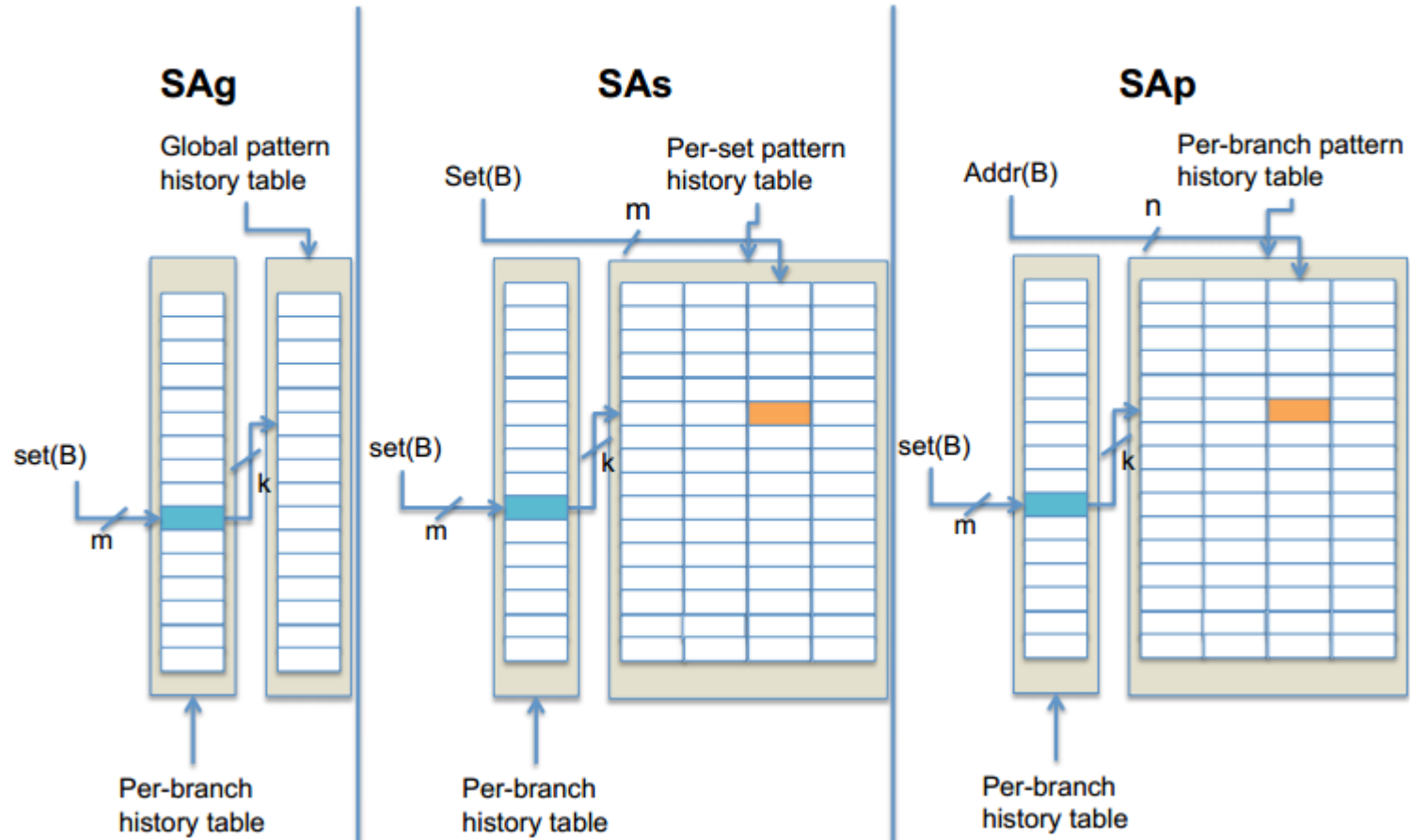

Branch Target Buffer

- A look-up table with the PC addresses of the branches. When the PC matches it provides the target address (target PC) of the branch and the taken/not-taken prediction.
- Store the ***predicted-taken branches only***

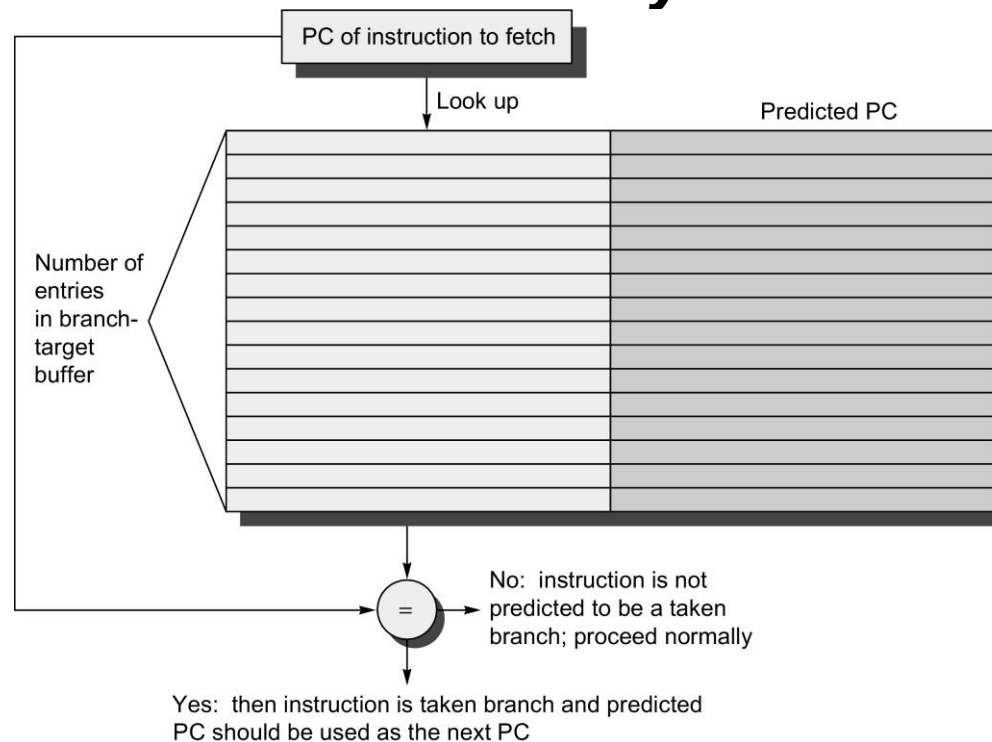

Branch Target Buffer

- The Branch Target Buffer (BTB) is accessed in the IF stage: save one clock cycle.

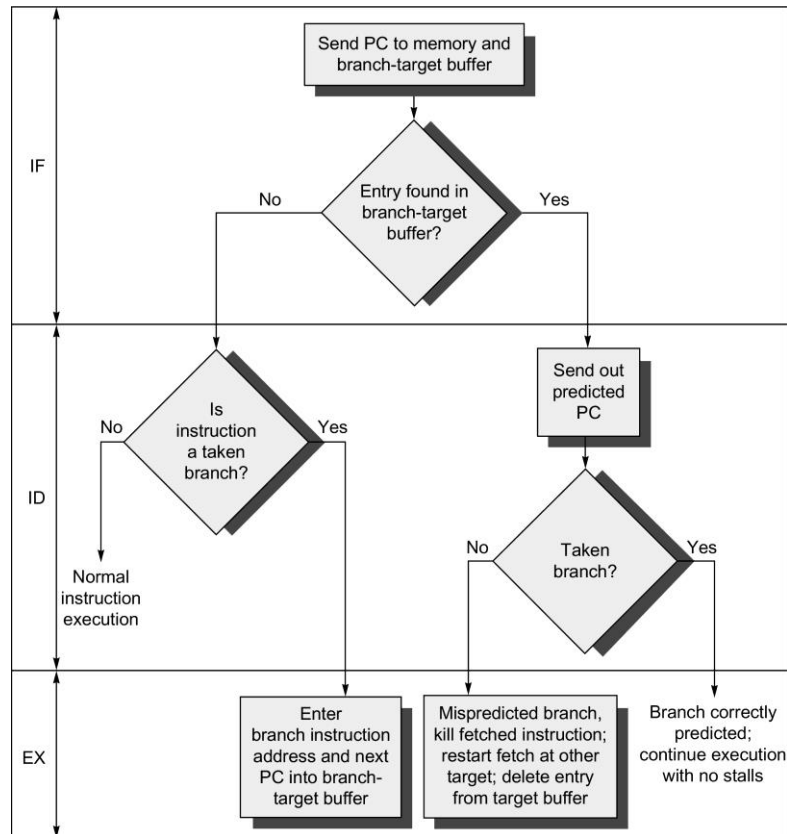

Instruction in buffer	Prediction	Actual branch	Penalty cycles
Yes	Taken	Taken	0
Yes	Taken	Not taken	2
No		Taken	2
No		Not taken	0

Branch Folding

- Save one or more target instructions together with the target address inside the Branch Target Buffer (BTB).
 - could cause longer BTB access time...
 - Zero-cycle branches: replace the branch with the target instruction
 - Only for unconditional branches!

Indirect Jumps

- Indirect procedure calls, switch/case statements, gotos. The majority is procedure/function returns.
- **Problem** → accuracy low when procedure is called from multiple sites.
- **Solution** → small buffer of return addresses operating as a stack (Return Address Stack). This structure caches the most recent return addresses: pushing a return address on the stack at a call and popping one off at a return.

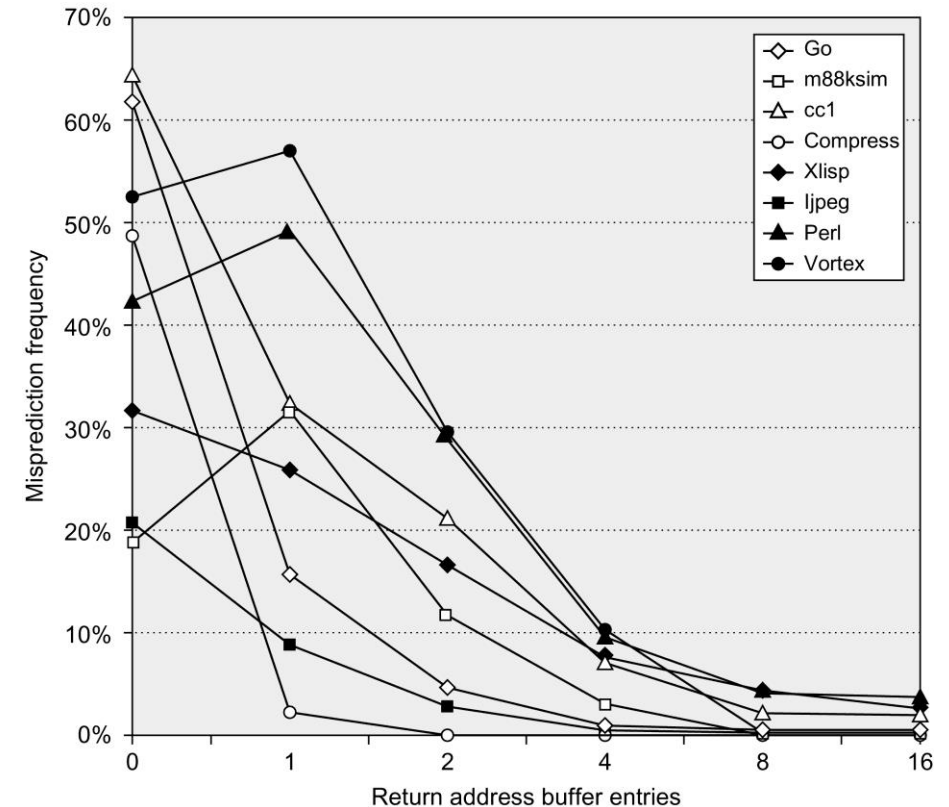

In SPEC95 benchmarks,
procedure returns account for
more than 15% of the branches

Predicated Execution

- Avoid branch prediction by converting branches to conditionally executed instructions:
- **if (x) then A = B op C else NOP**
 - If false, then neither store result nor cause exception
 - Expanded ISA of Alpha, MIPS, PowerPC, SPARC have conditional move; PA-RISC can annul any following instr.
 - IA-64: 64 1-bit condition fields selected so conditional execution of any instruction
- **Convert control dependence to data dependence**
 - Reduce branch pressure (reduce pred. table updates)
 - Conditional Move (CMOV) is very common

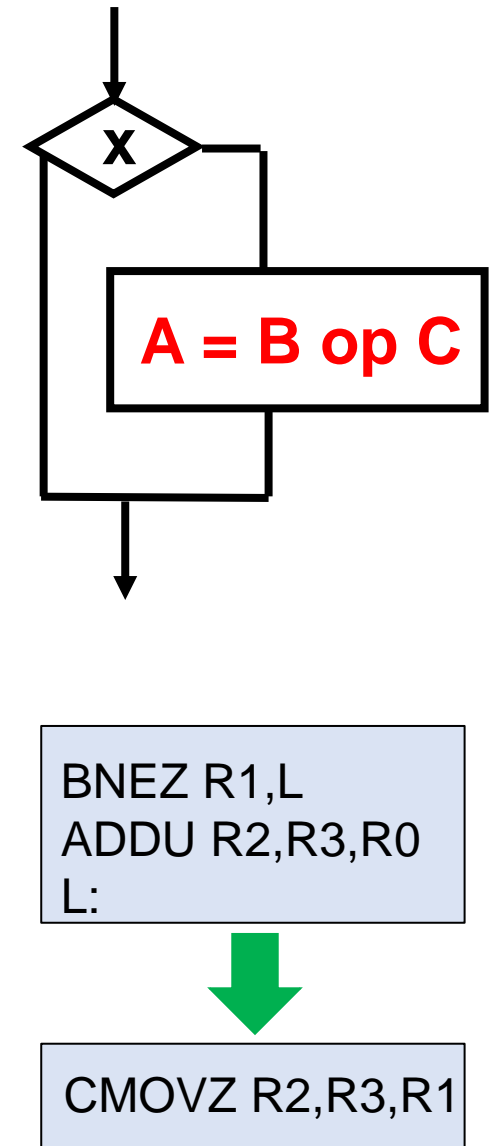

Predicated Execution

- Drawbacks of conditional instructions
 - Still takes a clock even if “annulled”
 - Stall if condition evaluated late
 - Complex conditions reduce effectiveness; condition becomes known late in pipeline

Dynamic Branch Prediction

- Branch prediction is of critical importance for the performance of the processor and the system
 - Prediction is exploiting “information compressibility” in execution
- **Branch History Table:** 2-bits for loop accuracy
- **Correlation:** Recently executed branches correlated with next branch
 - Either different branches (GA)
 - Or different executions of same branches (PA).
- **Branch Target Buffer:** include branch address & prediction
- **Predicated Execution** may reduce the number of branches and the rate of branch mispredictions